

Workshop Manual

**Renoveringsdata
Overhaul data**

C
2(0)

MB10A

Renoveringsdata Overhaul data

Marin motor Marine engine MB10A

Innehåll Contents

Safety information	2
Introduction	2
Important	2
General information	5
About the Workshop Manual	5
Spare parts	5
Certificated engines	5
Overhaul data	6
References to Service Bulletins	19

Safety Information

Introduction

The Workshop Manual contains technical data, descriptions, and repair instructions for the designated Volvo Penta products or product versions. Make sure that the correct workshop literature is used.

Read the following safety information and the *General Information* and *Repair Instructions* in the Workshop Manual carefully before starting service work.

A careless movement or dropped tool while working in the vicinity of an engine that is running, can in the worst case lead to injury. Observe caution on hot surfaces (exhaust pipe, turbo, charge air pipe, starter element etc.) and hot fluids in the lines and hoses of an engine that is running, or has just been started. Refit all guards dismantled during service work before starting the engine.

Important

The following special warning symbols are used in the Workshop Manual and on the product.

 **WARNING!** Warns of risk of bodily injury, serious damage to product or property, or that a serious malfunction can occur if the instructions are not followed.

 **IMPORTANT!** Used to attract attention to things that can cause damage or malfunction to product or property.

NOTE! Used to attract attention to important information, to simplify work procedures or handling.

The following list provides an overview of the risks and cautionary procedures that should always be observed.

 Prevent the engine from being started by disconnecting the power with the main switch (switches) and locking it (them) in disconnected mode before the service work is begun. Attach a warning sign in the cabin.

 As a rule, all service work should be performed on an idle engine. Some work, e.g. certain adjustments, require the engine to be running. Approaching an engine that is running is a safety risk. Remember that loose clothes or long hair can fasten in rotating parts and cause severe injury.

 Make sure that the warning or information decals on the product are always clearly visible. Replace labels that have been damaged or painted over.

 Never start the engine unless the air filter is fitted. The rotating compressor wheel in the turbo can cause severe injury. Foreign objects in the inlet pipe can also damage the machine.

 Never use starter spray or the like. Explosion risk in the inlet pipe. Risk of personal injury.











 Avoid opening the filler cap for coolant when the engine is hot. Steam or hot coolant can spray out. Open the filler cap slowly and release the overpressure in the cooling system. Observe extreme caution if the cock or plug, or coolant pipe, must be dismantled on a hot engine. Steam or hot coolant can flow out unexpectedly.

 Hot oil can cause burn injuries. Avoid skin contact with hot oil. Make sure that the oil system is not pressurised before working on it. Never start, or run the engine with the oil filler cap removed in view of the risk of ejecting oil.

 Stop the engine and close the bottom valve before working on the cooling system.

 Only start the engine in a well-ventilated area. Exhaust fumes and crankcase gases should be led out of the engine compartment or workshop when working in closed environments.

 Always use protective glasses for work where there is a risk of splintering, sparks, or splashing of acid or other chemicals. The eyes are extremely sensitive, and an injury can cause blindness!

-  Avoid skin contact with oil! Prolonged or frequent skin contact with oil can degrease the skin, resulting in irritation, drying out, eczema, and other skin complaints. Used oil is more dangerous than new oil from the health care point of view. Use protective gloves and avoid oil drenched clothes and rags. Wash your hands regularly, especially before meals. Use special hand cream to counteract drying out, and to simplify cleaning the skin.
-  The majority of chemicals intended for the product (e.g. engine and timing gear oils, glycol, petrol and diesel oil) or chemicals for workshop use (e.g. degreasing agent, enamels and solvents) are hazardous to health. Read the instruction on the pack carefully. Always follow the given safety instructions (e.g. the use of breathing protection, protective glasses, or gloves, etc.) Make sure that other personnel are not exposed to hazardous substances, e.g. by inhaling the air. Make sure there is adequate ventilation. Handle consumed and surplus chemicals in the prescribed manner.
-  Observe extreme caution when tracing fuel leaks in fuel systems and when testing fuel nozzles. Wear protective glasses. The jet from a fuel nozzle has a very high pressure and penetrating force. The fuel can penetrate deeply into bodily tissue and cause serious injury. Risk of blood poisoning.
-  All fuels, in similarity with chemicals, are inflammable. Make sure that naked flames, or sparks, cannot lead to ignition. Petrol, certain thinners, and hydrogen from batteries, are extremely inflammable and explosive when mixed with air. Smoking is prohibited! Ventilate well and take the necessary precautions before conducting welding or grinding work in the immediate vicinity. Always have a fire extinguisher handy in the workshop.
-  Make sure that rags drenched in oil and petrol, including old fuel and lubricant filters, are stored safely. Oil drenched rags can in certain conditions self-ignite. Old fuel and oil filters are environmentally hazardous waste, and together with spent lubricant, contaminated fuel, paint residue, solvent, degreasing agent and suds, should be handed in to a waste handling unit for destruction.
-  Batteries must never be exposed to naked flames or electrical sparks. Never smoke in the vicinity of batteries. Hydrogen develops when batteries are charged, which in combination with air forms an explosive gas. This gas is highly inflammable and very explosive. One spark from connecting the batteries incorrectly is sufficient to cause the battery to explode and cause injury. Do not touch the connection when starting (risk of spark) and do not lean over the batteries.
-  Never confuse the plus and minus terminals when fitting the batteries. This can cause serious damage to the electrical equipment. Check the wiring diagram.
-  Always use protective glasses when charging and handling batteries. The battery electrolyte contains strongly corrosive sulphuric acid. On skin contact, wash with soap and plenty of water. If battery acid gets into the eyes, rinse immediately with water, and contact a doctor without delay.
-  Stop the engine and switch off the power with the main switch (switches) before working on the electrical system.
-  Adjustment of the clutch should be conducted when the engine is idle.
-  Use the lifting hooks mounted on the engine/reversing gear when lifting the drive unit. Always check that the lifting equipment is in good condition and has the correct capacity for the lift (weight of engine plus reversing gear and extra equipment where appropriate). For safe handling, and to avoid damaging the components mounted on top of the engine, the engine should always be lifted with a lifting bar adjusted to the engine. All chains or wires should run in parallel with each other and as perpendicular to the top of the engine as possible. Special lifting equipment may be required to ensure the right balance and safe handling if other equipment connected to the engine alters its centre of gravity. Never carry out work on an engine only supported by lifting equipment.

 Never work alone when heavy components are to be dismantled, even when safe lifting (e.g. lockable block and tackle) equipment is used. In most cases, two persons are required even when lifting equipment is used: one to handle the equipment and one to make sure that components are not damaged. When working on-board a boat always make sure in advance that there is sufficient space to allow dismantling in situ, without the risk of personal injury or damage to materials.

 **WARNING!** The components in the electrical system and in the fuel system on Volvo Penta products are designed and manufactured to minimise the risks of explosion and fire. The engine must not be run in environments surrounded by explosive media.

 When cleaning with high-pressure wash, observe the following: Never point the jet of water at seals, rubber hoses, or electrical components. Never use the high-pressure function when washing the engine.

 **NOTE!** Pressure pipes must not bent, turned, or exposed to other strain. Replace damaged pressure pipes.

 Always use Volvo Penta recommended fuel. See the instruction handbook. The use of inferior quality fuel can damage the engine. The use of inferior fuel in a diesel engine can cause the control rod to jam and the engine to overspeed, with the risk of personal injury or damage to the machine. Inferior fuel can also lead to higher maintenance costs.

General Information

About the Workshop Manual

This Workshop Manual contains technical information, descriptions, and repair instructions for the standard versions of the engine units MB10A.

The Workshop Manual may show work procedures conducted on an optional engine according to the above list. This implies that the illustrations and diagrams that present certain parts, may in some cases not agree with the other engines. The repair methods remain essentially the same, however. Wherever there is a difference, this is clearly indicated and important differences are reported separately. The engine designation and number are given on the number plate. The motor designation and number should always be given during all correspondence.

The Workshop Manual is primarily produced for Volvo Penta service workshops and their qualified personnel. It is therefore assumed that persons using this manual have a basic knowledge of marine drive systems, and can perform the relevant work of a mechanical and electrical nature.

Volvo Penta continuously develops its products, and therefore reserves the right to introduce modifications. All the information in this manual is based on product data available prior to publication. Any amendments or service methods of essential importance that have been introduced for the product after this date are confirmed in the form of Service Bulletins.

Spare parts

Spare parts for the electrical and fuel systems are subject to different national safety requirements, e.g. U.S. Coast Guard Safety Regulations. Volvo Penta Genuine Spare Parts comply with these requirements. All types of damage resulting from the use of non genuine Volvo Penta spare parts for the product in question will not be regulated by the warranty undertakings of Volvo Penta.

Certificated engines

For service and repair on an engine certificated for any area where exhaust emissions are regulated by law, the following is important:

Certification means that an engine type is inspected and approved by the authorities. The engine manufacturer guarantees that all engines manufactured of that type correspond to the certified engine.

This places special requirements for maintenance and service as follows:

- The maintenance and service intervals recommended by Volvo Penta must be observed.
- Only genuine Volvo Penta replacement parts may be used.
- The service of injection pumps and injectors or pump settings must always be carried out by an authorized Volvo Penta workshop.
- The engine must not be modified in any way except with accessories and service kits approved by Volvo Penta.
- No modifications to the exhaust pipes and air supply ducts for the engine may be undertaken.
- Seals may only be broken by authorized personnel.

Otherwise the general instructions contained in the Instruction Book concerning operation, service and maintenance must be followed.



IMPORTANT! Late or inadequate maintenance/ service or the use of spare parts other than Volvo Penta original spare parts will invalidate AB Volvo Penta's responsibility for the engine specification being in accordance with the certificated variant.

Volvo Penta accepts no responsibility or liability for any damage or costs arising due to the above.

Renoveringsdata/Overhaul data

Allmänt/General

Typbeteckning	MB10A
Type designation	
Max effekt	11 kW (15 hk) (15 hp)
Max output	
Max varvtal	33 r/s (2000 r/m)
Max speed	
Kompressionsförhållande	6,5:1
Compression ratio	
Kompressionstryck vid startmotorvarv	7,5 kp/cm ² (107 p.s.i.)
Compression pressure at starter motor speed	
Cylinderantal	2
Number of cylinders	
Cylinderdiameter	88,9 mm (3.50 in.)
Bore	
Slaglängd	82,0 mm (3.23 in.)
Stroke	
Slagvolym	1,018 dm ³ (l) (62.1 cu.in.)
Displacement	
Vikt utan olja och vatten, ca	105 kg (232 lb.)
Weight without oil and water, approx.	
Tomgångsvarv	10 r/s (600 r/m)
Idling speed	

Cylinderblock/Cylinder block

Material	Gjutjärn
Material	Cast iron
Cylinderdiameter, standard	88,90–88,93 mm (3.5000–3.5012 in.)
Bore, standard	
Cylinderdiameter, överdim. 0,76 mm (0.0300 in.) .	89,66–89,69 mm (3.5299–3.5311 in.)
Bore, oversize 0.76 mm (0.0300 in.)	
Max. cylinderdeformation	0,01 mm (0.0004 in.)
Max. cylinder deformation	

Kolvar/Pistons

Material	Lättmetall
Material	Light-alloy
Höjd, total	71,0 mm (2.795 in.)
Height, total	
Höjd från kolvtoppscentrum till kolvtopp	46 mm (1.811 in.)
Height from gudgeon pin centre to piston top	
Kolvspel	0,03–0,05 mm (0.0012–0.0020 in.)
Piston clearance	
Kolvspel*	0,01–0,03 mm (0.0004–0.0012 in.)
Piston clearance*	

Kolvar finns som standard, standard + 0,03 mm och 0,76 mm överdim.

Pistons available as standard, standard + 0,03 mm (0.0012 in.) and 0.76 mm (0.0300 in.) oversize

Kolvdiаметer skall mätas 12 mm från nedre kanten.
The piston diameter should be measured 12 mm (0.47 in.) from the lower edge.

* Gäller från motor nr 2779.

* Valid from engine No. 2779.

Kolvringar/Piston rings

Kolvringsgap mätt i ringens öppning	0,40–0,55 mm (0.0157–0.0217 in.)
Piston ring gap measured in the opening of the ring	
Överdimension på kolvringar	0,76 mm (0.0300 in.)
Piston ring oversize	

Kompressionsringar/Compression rings

Märkta "TOPP". Övre ringen förkromad	
Marked "TOP". Top ring chromed	
Antal på varje kolv	2
Number on each piston	
Höjd	1,98 mm (0.0780 in.)
Height	
Kolvringsspel i spår	0,05–0,07 mm (0.0020–0.0028 in.)
Piston ring clearance in groove	

Oljeringar/Oil rings

Antal på varje kolv	1
Number on each piston	
Höjd	4,74 mm (0.1866 in.)
Height	
Kolvringsspel i spår	0,05–0,07 mm (0.0020–0.0028 in.)
Piston ring clearance in groove	

Kolvappar/Piston pins

Flytande lagrad. Låsring i båda ändar i kolven	
Floating fit. Circlips at both ends in piston	
Passning: I vevstake	Lätt tumtryck (noggrant löpande passning)
Fit: In connecting rod	Close running fit
Passning: I kolv	Tumtryck (skjutpassning)
Fit: In piston	Push fit
Diameter, standard	22,00 mm (0.8661 in.)
Diameter, standard	
Diameter, standard*	24,00 mm (0.9449 in.)
Diameter, standard*	
Diameter, överdim.	22,05 mm (0.8681 in.)
Diameter, oversize	
Diameter, överdim.*	24,05 mm (0.9469 in.)
Diameter, oversize*	

* Gäller från motor nr 2779.

* Valid from engine No. 2779.

Vevaxel/Crankshaft

Vevaxel, axialspel	0,25–0,45 mm (0.0098–0.0177 in.)
Crankshaft, end float	
Ramlager, radialspele	0,05–0,10 mm (0.0020–0.0039 in.)
Main bearings, radial clearance	
Vevlager, radialspele	0,03–0,08 mm (0.0012–0.0031 in.)
Big-end bearings, radial clearance	

Ramlager/Main bearings

Ramlagertappar/Main bearing journals

Diameter, standard	54,93–54,95 mm (2.1626–2.1634 in.)
Diameter, standard	
0,50 mm underdim.	54,43–54,45 mm (2.1429–2.1437 in.)
0.50 mm (0.0200 in.) undersize	
1,0 mm underdim.	53,93–53,95 mm (2.1232–2.1240 in.)
1.0 mm (0.0400 in.) undersize	

Ramlager/Main bearings

Diameter, standard	55,00–55,03 mm (2.1654–2.1665 in.)
Diameter, standard	
0,50 mm underdim.	54,50–54,53 mm (2.1457–2.1496 in.)
0.5 mm (0.0200 in.) undersize	
1,0 mm underdim.	54,00–54,03 mm (2.1260–2.1272 in.)
1.0 mm (0.0400 in.) undersize	

Vevlager/Big-end bearings

Vevlagertappar/Big-end bearing journals

Lagerlägets breddmått	31,85–31,90 mm (1.2539–1.2559 in.)
Width of bearing recess	
Lagerlägets breddmått*	29,95–30,05 mm (1.1791–1.1831 in.)
Width of bearing recess*	
Diameter, standard	54,09–54,11 mm (2.1295–2.1303 in.)
Diameter, standard	
Diameter, standard*	53,95–54,00 mm (2.1240–2.1260 in.)
Diameter, standard*	
0,25 mm underdim.	54,84–54,85 mm (2.1591–2.1594 in.)
0.25 mm (0.0100 in.) undersize	
0,25 mm underdim.*	53,70–53,75 mm (2.1142–2.1161 in.)
0.25 mm (0.0100 in.) undersize*	
0,50 mm underdim.	53,58–53,60 mm (2.1094–2.1102 in.)
0.50 mm (0.0200 in.) undersize	
0,50 mm underdim.*	53,44–53,49 mm (2.1039–2.1059 in.)
0.50 mm (0.0200 in.) undersize*	

* Gäller från motor nr 2779.

* Valid from engine No. 2779.

Vevlagerskålar/Big-end bearing shells

Tjocklek, standard	1,83–1,84 mm (0.0720–0.0724 in.)
Thickness, standard	
Tjocklek, standard*	1,98–1,99 mm (0.0780–0.0783 in.)
Thickness, standard*	
0,25 mm underdim.	1,96–1,97 mm (0.0772–0.0776 in.)
0.25 mm (0.0100 in.) undersize	
0,25 mm underdim.*	2,11–2,12 mm (0.0831–0.0835 in.)
0.25 mm (0.0100 in.) undersize*	
0,50 mm underdim.	2,09–2,10 mm (0.0823–0.0827 in.)
0.50 mm (0.0200 in.) undersize	
0,50 mm underdim.*	2,23–2,24 mm (0.0878–0.0882 in.)
0.50 mm (0.0200 in.) undersize*	

* Gäller från motor nr 2779.

* Valid from engine No. 2779.

Vevstakar/Connecting rods

Axialspel vid vevaxel	0,05–0,20 mm (0.0020–0.0079 in.)
End float on crankshaft	
Längd, centrum–centrum	144,9–145,1 mm (5.705–5.717 in.)
Length, centre–centre	

Kamaxel/Camshaft

Antal lager	2
Number of bearings	
Främre lagertapp, diameter	31,70–31,73 mm (1.2480–1.2492 in.)
Front bearing journal, diameter	
Bakre lagertapp, diameter	26,96–26,98 mm (1.0614–1.0622 in.)
Rear bearing journal, diameter	
Radialspel: Främre lager	0,02–0,08 mm (0.0008–0.0031 in.)
Radial clearance: Front bearing	
Radialspel: Bakre lager	0,02–0,06 mm (0.0008–0.0024 in.)
Radial clearance: Rear bearing	
Axialspel	0,05–0,35 mm (0.0020–0.0138 in.)
Axial clearance	

Kamaxellager/Camshaft bearings

Främre lager, diameter	31,75–31,78 mm (1.2500–1.2512 in.)
Front bearing, diameter	
Bakre lager, diameter	27,00–27,02 mm (1.0630–1.0638 in.)
Rear bearing, diameter	
Främre lagret brotschas efter ipressning	
Broach the front bearing after pressing in	

Ventiler/Valves

Inlopp/Intake

Tallriksdiameter	34 mm (1.339 in.)
Valve head diameter	
Spindeldiameter	7,95–7,97 mm (0.3130–0.3138 in.)
Stem diameter	
Ventilens sätesvinkel	45,5°
Valve seat angle	
Cylinderblockets sätesvinkel	45°
Seat angle in cylinder block	
Sätets bredd i cylinderblocket	1,4–2,0 mm (0.055–0.079 in.)
Seat width in cylinder block	
Spel, varm motor	0,30 mm (0.012 in.)
Clearance, warm engine	
Spel, kall motor	0,35 mm (0.014 in.)
Clearance, cold engine	

Utlopp/Exhaust

Tallriksdiameter	30 mm (1.181 in.)
Valve head diameter	
Spindeldiameter	7,92–7,94 mm (0.3118–0.3126 in.)
Stem diameter	
Ventilens sätesvinkel	45,5°
Valve seat angle	
Cylinderblockets sätesvinkel	45°
Seat angle in cylinder block	
Sätets bredd i cylinderblocket	1,4–2,0 mm (0.055–0.079 in.)
Seat width in cylinder block	
Spel, varm motor	0,35 mm (0.014 in.)
Clearance, warm engine	
Spel, kall motor	0,45 mm (0.018 in.)
Clearance, cold engine	

Ventilstyrningar/Valve guides

Längd	52 mm (2.047 in.)
Lenght	
Innerdiameter	8,00–8,02 mm (0.3150–0.3157 in.)
Inner diameter	
Spel, ventilspindel–styrning, inloppsventil	0,03–0,07 mm (0.0012–0.0028 in.)
Clearance, valve stem–guide, intake valve	
Spel, ventilspindel–styrning, utloppsventil	0,06–0,10 mm (0.0024–0.0039 in.)
Clearance, valve stem–guide, exhaust valve	

Ventilfjädrar/Valve springs

Längd, utan belastning, ca	46 mm (1.811 in.)
Lenght, unloaded, approx.	
Längd med belastning 272–318 N (27,2–31,8 kp) .	40 mm (1.575 in.)
Lenght with load of 272–318 N (27.2–31.8 kp) .	
(60.0–70.1 lb.)	
Längd med belastning 782–868 N (78,2–86,8 kp) .	30 mm (1.181 in.)
Lenght with load of 782–868 N (78.2–86.8 kp)	
(172.4–191.4 lb.)	

Smörjsystem/Lubricating system

Oljerymd, exkl. oljerenare	1,5 dm ³ (l) (1.60 US qts.)
Oil capacity, excluding oil filter	
Oljerymd, inkl. oljerenare	1,75 dm ³ (l) (1.85 US qts.)
Oil capacity, including oil filter	
Oljetryck vid tomgångsvarv, varm motor	1–2 kp/cm ² (14–28 p.s.i.)
Oil pressure at idling speed, warm engine	
Oljetryck vid fullvarv, varm motor	4 kp/cm ² (57 p.s.i.)
Oil pressure at max speed, warm engine	
Smörjmedel	Motorolja Service SC, SD eller SE
Oil grade	Engine oil Service SC, SD or SE
Viskositet	Multigradeolja SAE 10W–30
Viscosity	Multigrade oil SAE 10W–30

Smörjoljerenare/Oil filter

Typ	Fullflödesrenare
Type	Full-flow filter
Fabrikat	Wix
Make	

Smörjoljepump/Oil pump

Typ	Kugghjulspump
Type	Gear pump
Kuggantal på varje hjul	10
Number of teeth on each gear	
Axialspel	0,07–0,14 mm (0.0028–0.0055 in.)
End float	

Reduceringsventilens fjäder/Relief valve spring

Längd, obelastad	40,0 mm (1.575 in.)
Length, unloaded	
Längd, belastad med 23–27 N (2,3–2,7 kp)	34,0 mm (1.339 in.)
Length, loaded with 23–27 N (2.3–2.7 kp) (5.07–5.95 lb.)	
Längd, belastad med 33–37 N (3,3–3,7 kp)	31,5 mm (1.240 in.)
Length, loaded with 33–37 N (3.3–3.7 kp) (7.28–8.16 lb.)	

Bränslesystem/Fuel system**Bränslepump/Fuel pump**

Typ	Membranpump
Type	Diaphragm pump
Fabrikat	Pierburg: PE15685
Make	
matartryck	0,2 kp/cm ² (3 p.s.i.)
Feed pressure	

Förgasare/Carburetor

Typ	Stigförgasare
Type	Updraught carburetor
Fabrikat och beteckning	Solex 26VBN2
Make and designation	
Venturi	K22
Venturi	
Hudvmunstycke	Gg 102,5
Main jet	
Tomgångsmunstycke	Gvn 45
Idling jet	
Emulsionsmunstycke	S 16
Emulsion jet	
Kompensationsmunstycke	a 160
Compensate jet	
Nålventil	P 1,2
Needle valve	
Flottör	F 9,1 gr
Float	
Spjäll	13°
Throttle	

Elsystem/El. system

Batteri/Battery

Jordanslutning	Negativ (-)
Earthed	
Spänning	12 V
Voltage	
Kapacitet	34 Ah (SIBA), 60 Ah (Bosch)
Capacity	
Elektrolytens specifika vikt: Fulladdat batteri	1,275–1,285 g/cm³ (0.0460–0.0464 lb/cu.in.)
Specific gravity of electrolyte: Fully charged battery	
Urladdat batteri	1,230 g/cm ³ (0.0444 lb/cu.in.)
Discharged battery	

Startgenerator/Starter generator

Tidigare utförande/Earlier prod.

Typ	SIBA DS418
Type	
Startmotoreffekt	0,59 kW (0,8 hk) (0.8 hp)
Starter motor output	
Generatoreffekt	60 W
Generator output	

Senare utförande/Later prod.

Typ	Bosch 0 010 350 004
Type	
Startmotoreffekt	0,74 kW (1 hk) (1 hp)
Starter motor output	
Generatoreffekt, kontinuerlig	90 W
Generator output, continuous	
Generatoreffekt, max.	135 W
Generator output, max	

Tändsystem/Ignition system

Cylindermärkning	1 närmast svänghjulet
Marking of cylinder	1 nearest the flywheel
Tändstift	Bosch W 175T35 eller motsvarande
Spark plug	Bosch W 175T35 or corresponding
Tändstiftgap	0,7 mm (0.029 in.)
Spark plug gap	

Fördelare/Distributor

Tid. utf./Early prod.

Tändfördelare Bosch, typ	JF2 0231 109 014
Distributor, Bosch type	
Grundinställning	-3° (f.ö.d.) (B.T.D.C.)
Basic setting	
Stroboskopinställning 20 r/s (1200 r/m)	9,5°
Stroboscope setting 20 r/s (1200 r/m)	
Kontaktgap	0,4 mm (0.016 in.)
Gap	
Slutningsvinkel	60°±3°
Cam angle	

Sen. utf./Late prod.

Tändfördelare Bosch, type	JF2 0231 109 015
Distributor, Bosch type	
Grundinställning	2° (e.ö.d.) (A.T.D.C)
Basic setting	
Stroboskopinställning 20 r/s (1200 r/m)	11°
Stroboscope setting 20 r/s (1200 r/m)	
Kontaktgap	0,4 mm (0.016 in.)
Gap	
Slutningsvinkel	60°±3°
Cam angle	

Kylsystem/Cooling system**Termostat/Thermostat**

Typ	Bälghermostat
Type	Bellows thermostat
Börjar öppna vid	60°C (140°F)
Starts opening at	
Fullt öppen vid	74°C (165°F)
Fully open at	

Förslitningstoleranser/Wear tolerances**Cylindrar/Cylinders**

Borras vid förslitning (om motorn har onormal oljeförbrukning)	0,30 mm (0.0118 in.)
To be rebored when wear amounts to (if engine has abnormal oil consumption)	

Vevaxel/Crankshaft

Max tillåten ovalitet på ramlagertappar	0,05 mm (0.0020 in.)
Max permissible out-of-round on main bearing journals	
Max tillåten ovalitet på vevlagertappar	0,07 mm (0.0028 in.)
Max permissible out-of-round on big-end bearing journals	
Max axialspelet på vevaxel	0,50 mm (0.0197 in.)
Max crankshaft end float	

Ventiler/Valves

Max tillåtet spel mellan ventilspindel och ventilstyrning	0,15 mm (0.0059 in.)
Max permissible clearance between valve stem and valve guide	
Max tillåten förslitning, ventilspindel	0,02 mm (0.0008 in.)
Max permissible wear, valve stem	

Kamaxel/Camshaft

Max tillåten ovalitet (med nya lager)	0,07 mm (0.0028 in.)
Max permissible out-of-round (with new bearings)	
Max tillåten förslitning, lager	0,02 mm (0.0008 in.)
Max permissible wear, bearings	

Åtdragningsmoment/Tightening torques

Cylinderlocksskruvar	83 Nm (8,3 kpm) (60 lb.ft.)
Cylinder head screws	
Vevlagermuttrar	55 Nm (5,5 kpm) (40 lb.ft.)
Big-end bearing nuts	
Vevlagermuttrar*	75 Nm (7,5 kpm) (55 lb.ft.)
Big-end bearing nuts*	
Svänhjuls-mutter	380 Nm (38 kpm) (275 lb.ft.)
Flywheel nut	
Tändstift	38 Nm (3,8 kpm) (27,5 lb.ft.)
Spark plugs	

* Gäller från motor nr 2779.

* Valid from engine No. 2779.

Åtdragnings-schema för cylinderlocksskruvar

Tightening sequence for cylinder head screws

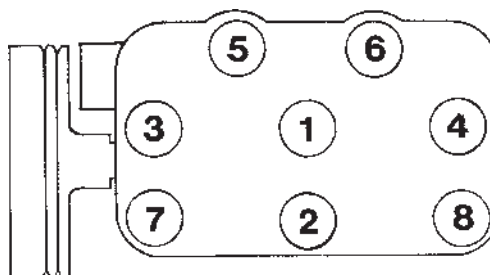

Remspänning/Belt tension

Startgenerator–svänghjul	4 mm (0.158 in.) med normalt tumtryck
Starter generator–flywheel	4 mm (0.158 in.)

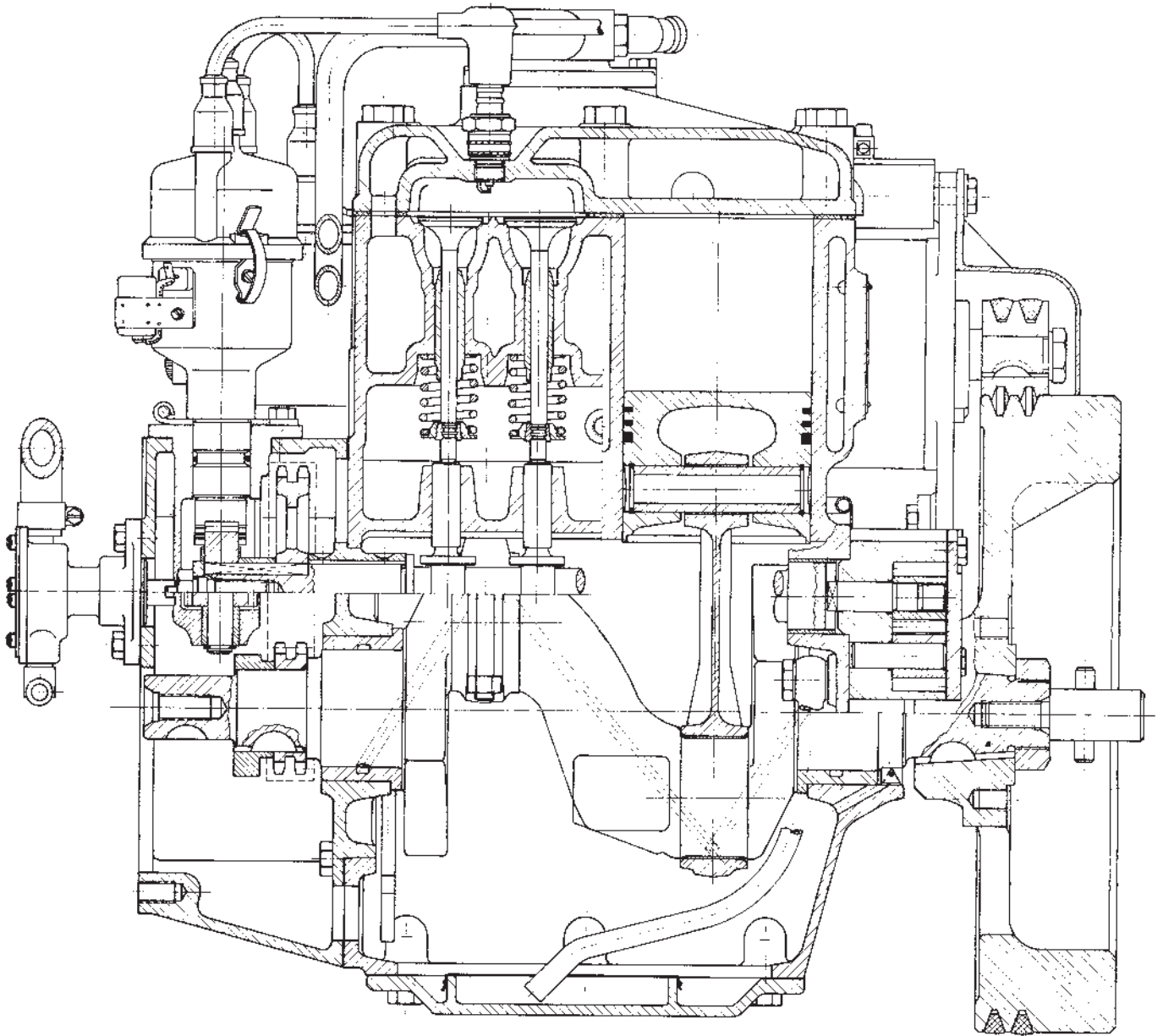

Längdsnitt
Longitudinal section

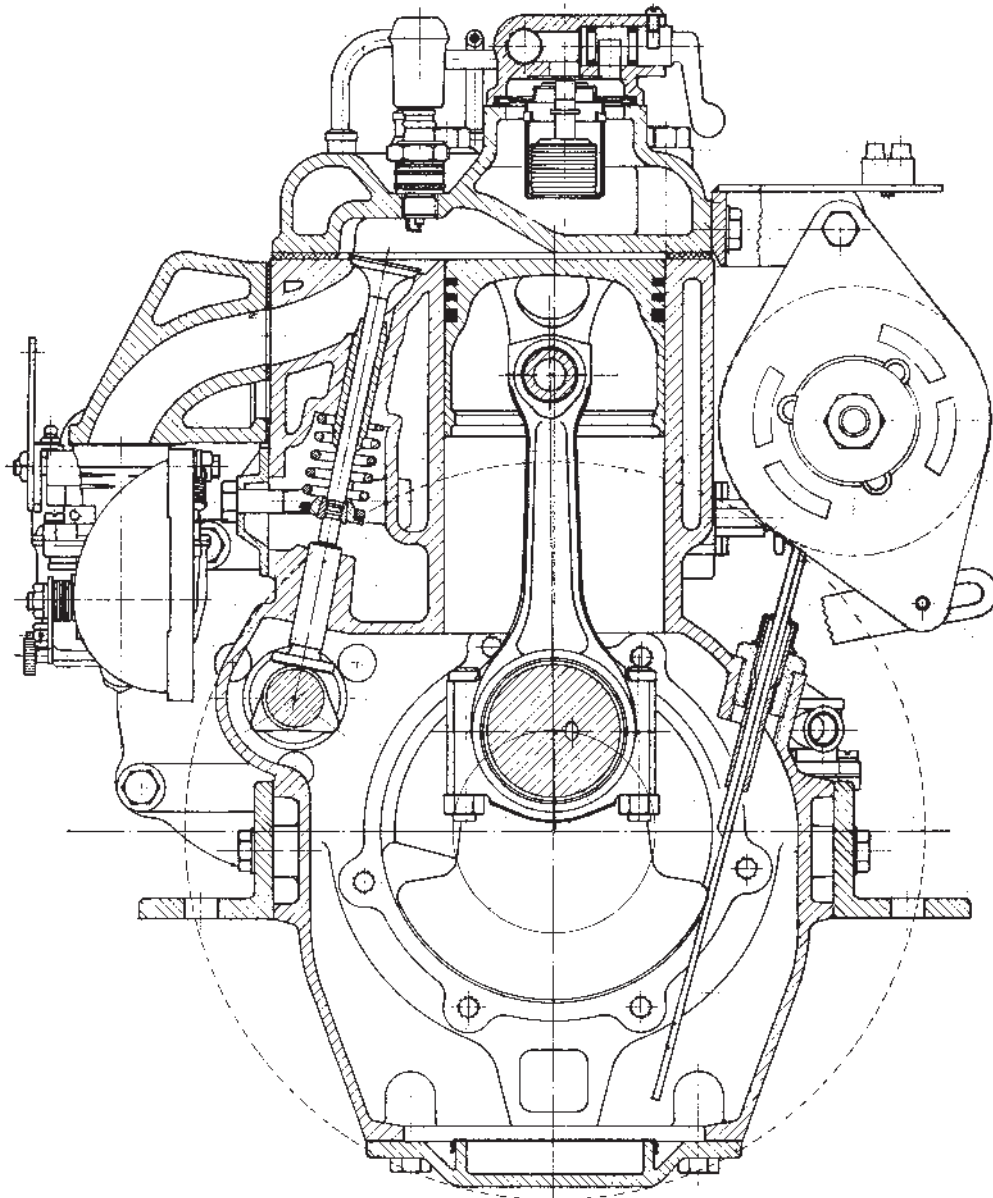

Tvårsnitt
Cross-section

Ny startgenerator/New starter-generator

Fr.o.m motornr: 2779 utrustas motor MB10A med en ny och effektivare startgenerator av fabrikat Bosch. Detta medför att ett batteri med **högre kapacitet (max. 60 Ah)** kan användas.

OBS! Tidigare motorer, utrustade med startgenerator Siba, kan endast ha batteri med kapacitet max. 32 Ah.

With effect from engine No. 2779, the MB10A engine is fitted with a new, more effective starter-generator, of Bosch make. A battery with **higher capacity (max. 60 Ah)** can thus be used as a result.

NOTE! Earlier engines fitted with the Siba starter-generator can only have a battery with capacity max. 32 Ah.

Positionslista/List of components

1. Nyckelströmbrytare
Key switch
2. Strömbrytare, extra
Switch, extra
3. Kontrollampa, laddning
Warning lamp, battery charging
4. Kontrollampa, oljetryck
Warning lamp, oil pressure
5. Kopplingsstycke, instr.tavla
Connector, instr. panel
6. Kopplingsstycke, motor
Connector, engine
7. Oljetrycksgivare
Oil pressure sender
8. Tändspole
Ignition coil
9. Tändfördelare
Distributor
10. Startgenerator
Dynastart
11. Ledningshölje
Cable sleeve
12. Säkring
Fuse
13. Regulator
Regulator
14. Batteri
Battery
15. Huvudströmbrytare
Master switch

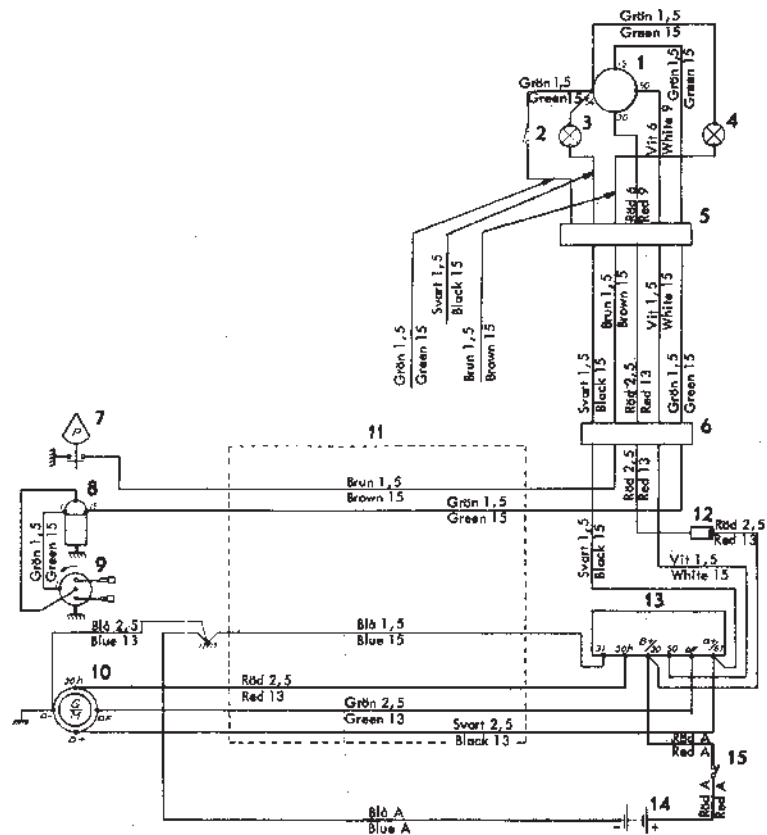

New wiring diagram MB10A

The MB10A is with effect from engine no 6361 fitted with a new wiring diagram.

Positionslista/List of components

1. Nyckelströmbrytare
Key switch
2. Strömbrytare, extra
Switch, extra
3. Kontrolllampa, startgenerator
Warning lamp, dynastart
4. Kontrolllampa, oljetryck
Warning lamp, oil pressure
5. Kopplingsstycke, instr.tavla
Connector, instr. panel
6. Kopplingsstycke, motor
Connector, engine
7. Oljetrycksgivare
Oil pressure sender
8. Tändspole/Ignition coil
9. Tändfördelare
Distributor
10. Startgenerator
Dynastart
11. Ledningshölje
Cable sleeve
12. Säkring
Fuse
13. Kontrolllampa, växelströmgenerator
Warning lamp, alternator
14. Batteri, startgenerator
Battery, dynastart
15. Batteri, växelströmgenerator
Battery, alternator
16. Laddningsregulator, startgenerator
Charging regulator, dynastart
17. Relä, startgenerator
Relay, dynastart
18. Huvudströmbrytare
Master switch
19. Huvudströmbrytare
Master switch
20. Växelströmgenerator
Alternator
21. Regulator
Regulator

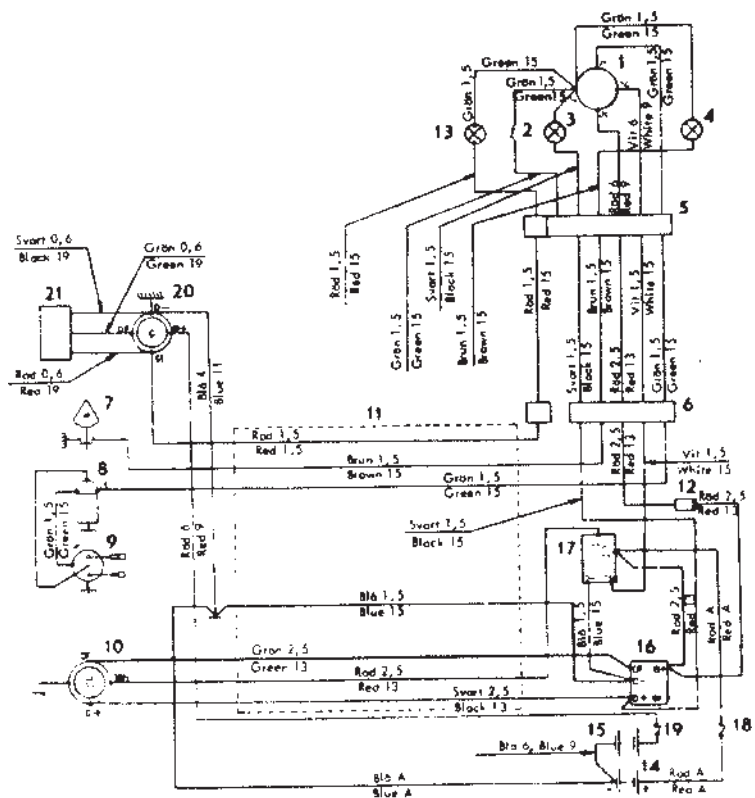

Anteckningar/Notes

A series of horizontal dotted lines for writing notes.

Report form

Do you have any complaints or other comments about this manual? Please make a copy of this page, write your comments down and post it to us. The address is at the bottom of the page. We would prefer you to write in English or Swedish.

From:
.....
.....
.....

Refers to publication:

Publication no.: Issued:

Suggestion/reasons:
.....
.....
.....
.....
.....
.....
.....
.....
.....
.....

Date:

Name:

AB Volvo Penta
Customer Support
Dept. 42200
SE-405 08 Gothenburg
Sweden

